

Greenwich Table

600 / 610

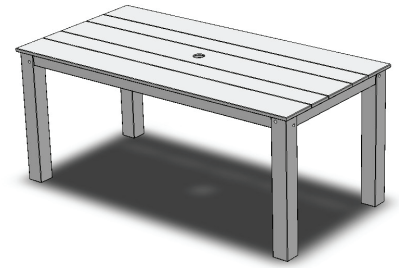

SEASIDE CASUAL



ASSEMBLY INSTRUCTIONS

1

PLEASE READ INSTRUCTIONS COMPLETELY BEFORE BEGINNING.

Carefully remove contents from box. Make sure that all parts and hardware are included using the Parts List below.

Tools Required: 4mm Allen Wrench (included); #2 Phillips Head Screwdriver; Socket set (Recommended: Rubber Mallet; Power Drill)

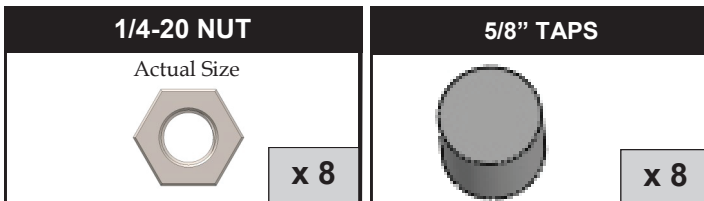
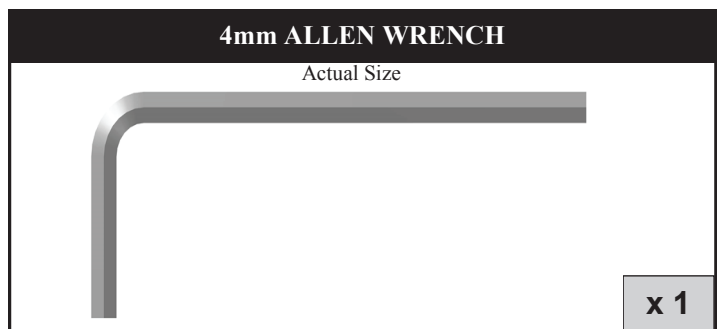
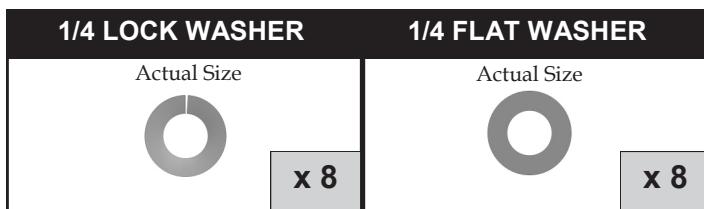
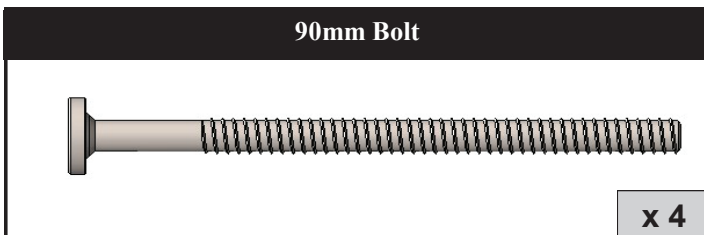
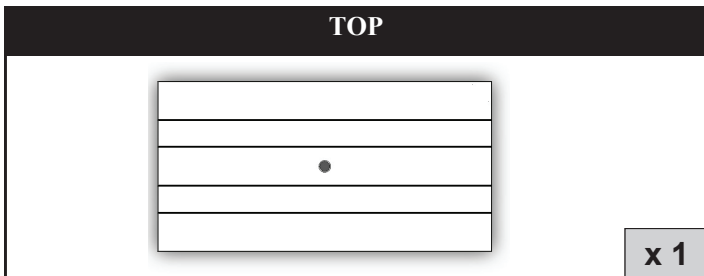

2

ATTACH TOP TO LEGS

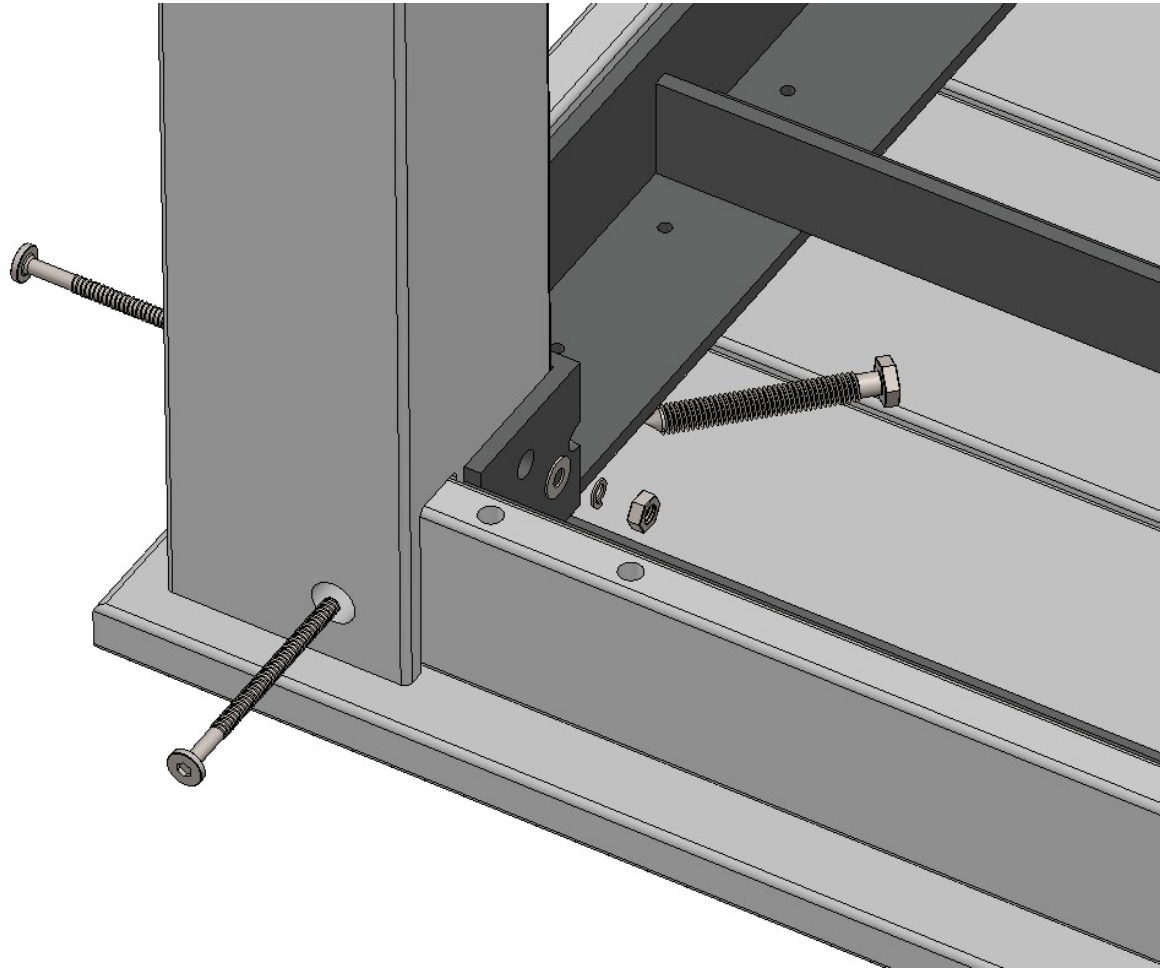

On a clean flat surface connect legs to Top using (2) 90mm Bolts, Washers, split washers, and nut (AS SHOWN). Finger tighten. Attach 3/8" LAG to inside of leg. Repeat with remaining legs. Do not over tighten. Plug holes with supplied 5/8" TAPS.